



# Product catalogue 2019 / 2020

Measuring. Testing. Automation.



# Contents



## Company

### Product overview

#### Measurement and testing devices

ProfiMessage

ProfiMessage D

Expert Vibro

Expert Logger

Expert Transient

Expert Key

Loggito

LogMessage 5000

Software channels

#### Software

ProfiSignal

ProfiSignal Go

ProfiSignal Basic

ProfiSignal Klicks

ProfiSignal Web

Delphin Data Center

ProfiSignal  
Interfaces, Runtime, Viewer

ProfiSignal Options  
Vibro, Audittrail, AlarmManagement, SQL

#### Complete systems

Measuring case / 19" systems / control cabinets

Universal testing device /  
64-channel thermocouple measurement device

#### Solutions for industries

Chemicals, pharmaceuticals, plastics / Mechanical engineering

Energy technology / Heating, air-conditioning, ventilation

#### Services

Application development

Calibration

Training / Installation / Service agreements



Page 4

Page 6

Page 8

Page 10

Page 12

Page 14

Page 16

Page 18

Page 20

Page 22

Page 24

Page 26

Page 28

Page 30

Page 32

Page 34

Page 36

Page 38

Page 40

Page 42

Page 44

Page 46

Page 48

Page 50

Page 54

Page 56



## Your **partner** for industrial **measurement and testing technology**

**Since 1980, Delphin Technology AG has been developing, manufacturing and marketing pioneering, high-quality measuring hardware and software solutions for industrial measurement and testing technology.**

We are a competent and reliable partner to worldwide customers – both for standard measurement systems and individualised complete systems. Our team of technical specialists are committed to their work and transform creative ideas into practical products. The main applications for our products range from measurement data acquisition and analysis, test stand automation and monitoring through to vibration measurement technology. Our products are being used in a wide variety of sectors, including electrical engineering, mechanical engineering, energy technology and the chemical and pharmaceutical industries.

### **Continuity – Focussing on customers**

We focus on our customers who then benefit from our technical know-how and our proven practical experience in applications from almost 40 years of development work in the field of industrial measurement technology. Working closely with customers and their applications is important to us and is reflected in our product range as well as in our long-standing customer relationships. Many medium-sized companies, globally renowned industrial groups as well as research laboratories, authorities and universities place their trust in us and benefit from our many years of experience.

### **Quality – Made in Germany**

A top priority is the continuous development of our products in accordance with the highest quality standards. Delphin Technology AG is certified according to ISO 9001:2015. This ensures that our products meet the most stringent quality requirements to provide reliable operation in your applications. With Delphin, you have the assurance that the products have been “Made in Germany”.

### **Innovation – Intelligent measurement technology**

Through continuous technological development, we aim to supply our customers worldwide with intelligent and universally usable data acquisition devices and intuitive measurement software. Our customers must be able to carry out their measurement and monitoring tasks at high-levels of efficiency and safety. We support you with our deep knowledge of products and applications and we are constantly working on new technical features and innovations which are protected by worldwide patents.

### **Flexibility – Individualised complete systems**

Flexibility and a non-hierarchical organisation are further building blocks in our corporate philosophy. This enables us to respond to the wishes of customers and to offer individualised complete solutions in addition to standardised systems. On request, we can manufacture individualised measuring cases, control cabinets and complete test stands and, with ProfiSignal software, program application software specifically tailored to your requirements.

### **Customer service**

Customer service is our number one priority. Our range of services includes project planning, installation, calibration, service hotline and training courses as well as project-based and individualised training. Installation and training are carried out by a competent team of experienced engineers at Delphin or at the customer’s premises. Our service packages guarantee you first-class support from the outset!





## Intelligent **measurement technology**

"We at Delphin supply our global customers with intelligent, universal data acquisition hardware and intuitive measurement software. This enables our customers to reliably and efficiently carry out their measurement and monitoring requirements."





## Data acquisition and data logger

## Test, trial & automation



### Loggito

Compact  
data acquisition



### Expert Logger

Stand alone data logger

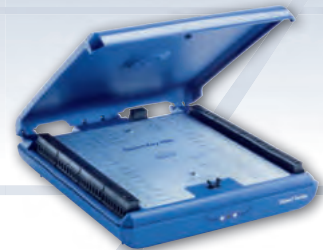

### Expert Key

PC-based measurement  
technology

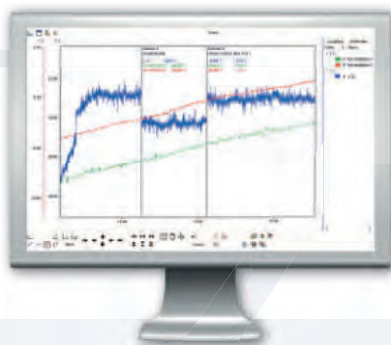

### ProfiSignal Go

Data acquisition and analysis



### ProfiSignal Basic

Operation and observation



# Measurement technology globally networked



**Vibration measurement**



**Monitoring & environment technology**

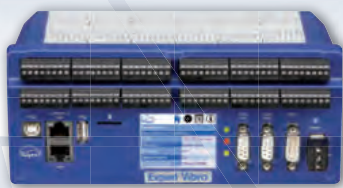

**Expert Vibro**

Vibration measurement

**Expert Transient**

Transient data acquisition

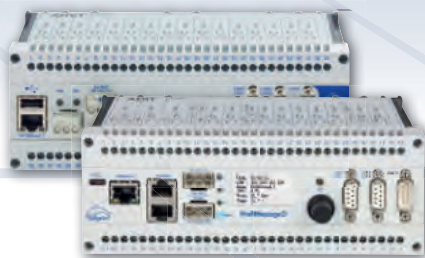

**ProfiMessage**

**ProfiMessage D**

Modulare measurement technology and automation



Compact measurement system



**ProfiSignal Klicks**

Automate and control



**ProfiSignal Web**

Web-based and mobile data acquisition



# ProfiMessage – Modular data acquisition

Do you need a modular, expandable and easy-to-use system for data acquisition, monitoring and automation of your machines, systems or test stands? Then the ProfiMessage series is for you the right choice.

The ProfiMessage devices can be adapted precisely to your requirements by using a range of I/O modules. The option of expanding master devices with slave devices enables you to also acquire data from many channels. The universal use of inputs for voltage, current and temperature measurement, as well as digital inputs as status or frequency inputs, make the devices highly flexible.

Connecting to existing machine infrastructure is extremely simple thanks to serial interfaces. At the same time, analog and digital measurement data can be processed together with data from fieldbus interfaces and stored independently in the device along with high-resolution time stamps for subsequent analysis. Integrated functions such as limit value monitoring, online calculation and logics enable easy preprocessing of measurement data.



ProfiMessage

I/O Modules	Analog inputs	Analog outputs	Frequency / Status inputs	Status inputs	Switch outputs	Total sampling rate
ADGT	8 channels, V / mV, 20 mA, RTD, thermocouples					60 Hz
ADIT	10 channels, V / mV, 20 mA, RTD, thermocouples	1 channel, 20 mA			1 channel	600 Hz
ADVT	15 channels, V / mV, 20 mA, thermocouples					600 Hz
ADFT	8 channels, V / mV, 20 mA	2 channels, 0 .. 10 VDC	2 channels	2 channels	4 channels	8 kHz
AMDT	8 channels, V / mV, 20 mA	2 channels, 0 .. 10 VDC	2 channels	2 channels	4 channels	10 .. 160 kHz
AAST	4 channels, V / mV, 20 mA, RTD, thermocouples	4 channels, 20 mA		2 channels	2 channels	600 Hz
IOIT				24 channels	1 channel	
OTPT				1 channel	24 channels	
DIOT			11 channels	1 channel	16 channels	



## Applications

- Monitoring of industrial processes
- Monitoring of installations and clean rooms
- Test stand automation
- Laboratory data acquisition
- Fault data acquisition
- Energy optimisation

## ProfiSignal

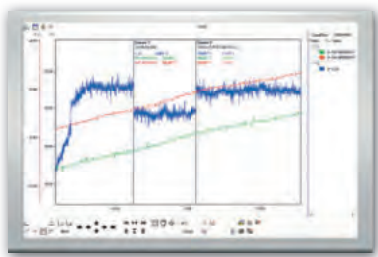

Offline



Online

LAN

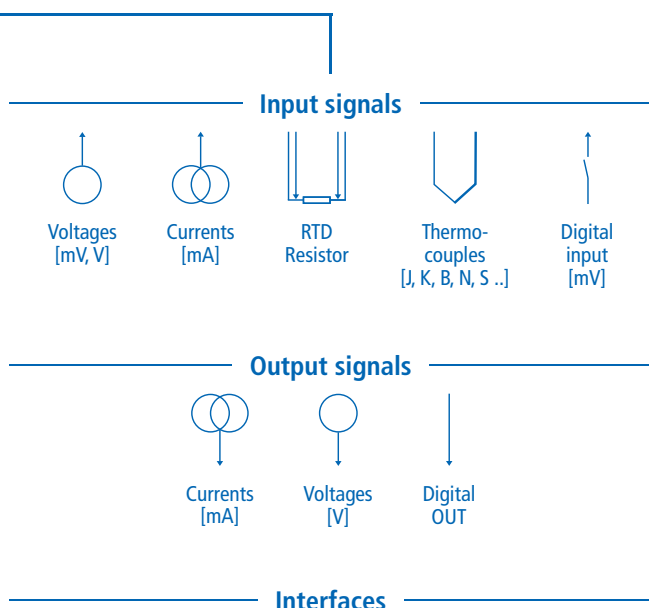

- Modbus TCP/RTU
- PROFIBUS DP, CAN RAW
- RS232, RS485

- OPC UA



## Product features

- Two slots for I/O modules in each master and slave device
- Options of a range of I/O modules
- Extendible system: option of up to 20 slave devices on one master device
- Automatic email notification in alarm events

## Sensor connection

- Universal analog inputs (mV, mA, thermocouples, RTD)
- Configurable analog outputs
- Switchable signals, frequency and pulse counters

## Interfaces

- Serial interfaces RS232, RS485
- Modbus TCP/RTU
- PROFIBUS DP, CAN RAW
- Configuration of individual ASCII protocols
- OPC UA

## Data storage

- Up to 14 GB internal storage
- External storage media (USB)
- Event-triggered recording with pre and post histories
- Push function

## Product highlights

- Modular
- Extendible
- Flexible I/O module options
- External data storage
- High galvanic isolation voltage

# ProfiMessage D – Modular measuring, monitoring

Do you want to build a bridge between Industry 4.0 and Big Data? Would you like to make your production more efficient, and acquire and analyse measurement data at high precision? The ProfiMessage D device series enables you to use measurement technology as a central component of your smart factory.

ProfiMessage D is the latest device in the proven Message series. ProfiMessage D devices have new features such as an integrated display with jog wheel for setting important network parameters and visualising predefined measurement values. PROFINET and OPC UA interfaces are also available for exchanging data between your systems, and a WLAN interface for wireless connection to PCs and routers. ProfiMessage D devices have been developed as modular measuring, control and monitoring devices. The master / slave device concept, with a range of I/O modules, continues to enable systems to be tailored to your needs. The I/O module inputs and outputs are differential, highly accurate and galvanically isolated. Monitoring and automation tasks can be performed using integrated software channels. Function modules are individually set-up, configured and processed within the device by the user.



ProfiMessage D

I/O Modules	Analog inputs	Analog outputs	Frequency / Status inputs	Status inputs	Switch outputs	Total sampling rate
ADGT	8 channels, V / mV, 20 mA, RTD, thermocouples					60 Hz
ADIT	10 channels, V / mV, 20 mA, RTD, thermocouples	1 channel, 20 mA			1 channel	600 Hz
ADVT	15 channels, V / mV, 20 mA, thermocouples					600 Hz
ADFT	8 channels, V / mV, 20 mA	2 channels, 0 .. 10 VDC	2 channels	2 channels	4 channels	8 kHz
AMDT	8 channels, V / mV, 20 mA	2 channels, 0 .. 10 VDC	2 channels	2 channels	4 channels	10 .. 160 kHz
AAST	4 channels, V / mV, 20 mA, RTD, thermocouples	4 channels, 20 mA		2 channels	2 channels	600 Hz
IOIT				24 channels	1 channel	
OTPT				1 channel	24 channels	
DIOT			11 channels	1 channel	16 channels	



# and automating

## Applications

- Modular data acquisition
- Process data acquisition and preprocessing
- Fault data recording and damage analysis
- Data automation for experiments and test stands
- Remote data monitoring for machines and systems
- Clean room monitoring
- Laboratory data acquisition and automation

ProfiSignal



Data acquisition and analysis

USB / LAN

LTE / WLAN

## Input signals

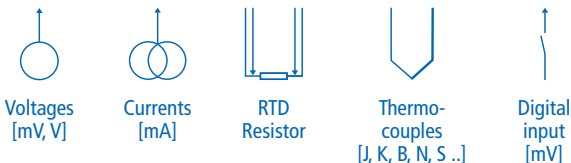

## Output signals

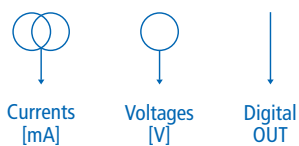

## Interfaces

- Modbus TCP/RTU
- PROFIBUS DP, CAN RAW
- RS232, RS485

- PROFINET
- OPC UA



## Product features

- Two slots for I/O modules in each master and slave device
- Options of a range of I/O modules
- Extendible
- Configurable internal display in the master device
- WLAN interface for wireless data transmission (optional)
- Automated email and textmessage alerts

## Sensor connection

- Universal analog inputs (mV, mA, thermocouples, RTD)
- Configurable analog outputs
- Switchable signals, frequency and pulse counters

## Interfaces

- Serial interfaces RS232, RS485
- PROFIBUS DP, CAN RAW
- PROFINET (optional)
- OPC UA, Modbus TCP/RTU
- Configuration of individual ASCII protocols

## Data storage

- 4 GB or 16 GB internal storage
- External storage media (USB, NAS)
- Event-triggered recording with pre and post histories
- Push function

## Product highlights

- Modular and extendible
- Flexible I/O module options
- Internal display
- Software channels for analysis, control, regulation and monitoring
- Versatile interfaces, e.g. PROFINET and OPC UA
- Internal data storage
- External data storage
- High galvanic isolation voltage

# Expert Vibro – The **vibration specialist**

Focusing on your systems! We show you how to see behind the scenes of your installation and gain a detailed picture of its condition. Acquiring vibration data and processing it online.

Vibration measurement becomes understandable with Expert Vibro. State-of-the-art processor technology in a compact design enables 4, 8, 12 or 16 synchronous vibration measurement channels with sampling rates of up to 50 kHz per channel, tailored to your needs. 24-bit A/D converters guarantee extremely high precision.

Flexible switching is possible between measuring voltages, currents, IEPE or shaft vibration sensors. Integrated comparators and digital inputs enable flexible and speed-synchronised triggering. Measurement data is monitored online and digital outputs can be switched in milliseconds when limit values are exceeded. Process data can also be recorded by using the relevant modules.

Vibration measurement using Expert Vibro is easy, even for newcomers. Intuitive configuration guarantees fast installation and short learning times.



Expert Vibro

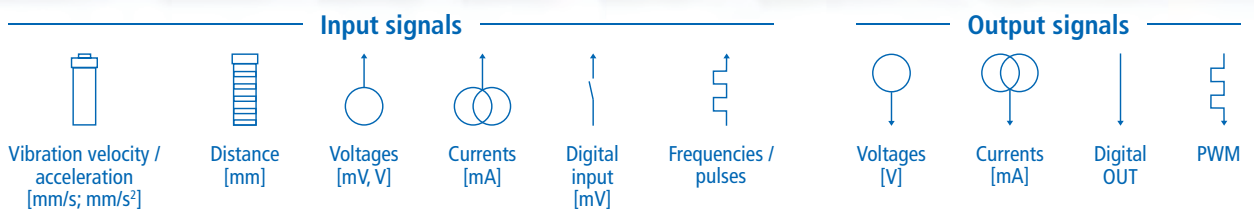

Inputs / outputs	Type 4	Type 8	Type 12	Type 16
Analog inputs (mV, mA)	4	8	12	16
Analog outputs (mV, mA)	4	4	4	4
Digital / frequency inputs	4	4	4	4
Digital outputs	8	8	8	8



## Applications

- Shaft vibration monitoring and analysis
- Monitoring of vibrations in machines and housings
- Rolling bearing monitoring and bearing damage diagnosis
- Spindle monitoring and balancing
- Combustion chamber vibration monitoring
- Gearbox vibration analysis
- Air-gap monitoring
- Mobile vibration measurement

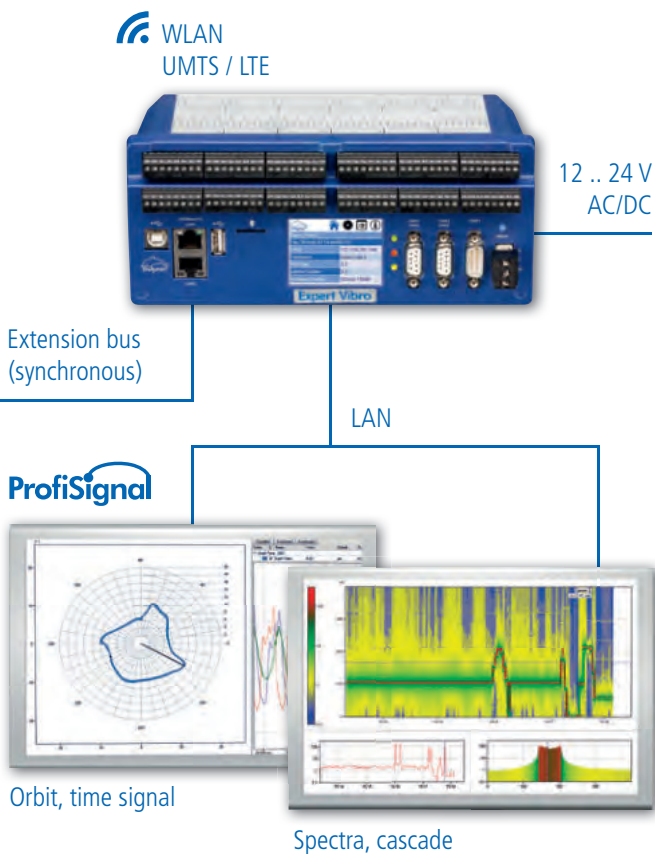

## Interfaces

- Modbus TCP/RTU
- PROFIBUS DP, CAN RAW
- RS232, RS485

- OPC UA



## Product features

- 4, 8, 12 or 16 individually triggerable vibration inputs
- Calculation and monitoring of characteristic values
- Online computation of measurement data
- Integrated analysis functions for gear and roller bearing monitoring, air-gap etc.
- Spectrum – online – up to 12,800 lines (FFT)
- Integration functions (two-stage)
- 50 kHz sampling rate per channel
- 24-bit A/D converter

## Sensor connection

- Software switchable analog inputs
  - Shaft vibration / distance sensors
  - Acceleration sensors
  - Vibration velocity sensors
  - mV / mA signals (pressure etc.)
- Switchable IEPE power supply
- Integrated comparators for KeyPhasor® sensors
- Measuring range up to  $\pm 25$  V
- Pluggable screw terminals

## Interfaces

- LAN, USB, WLAN (optional), LTE (optional)
- Serial interfaces RS232, RS485
- OPC UA, Modbus TCP/RTU
- PROFIBUS DP, CAN RAW
- Individual ASCII protocols

## Data storage

- 2 GB or 14 GB internal storage
- External storage media (USB, NAS)
- Triggered storage with pre and post histories

## Product highlights

- Synchronous analog inputs, 50 kHz sampling rate per channel
- Calculation and monitoring of characteristic values
- Spectrum – online – up to 12,800 lines (FFT), integrated IEPE power supply
- Extendible

# Expert Logger – Stand alone **data logger** with int

Do you need a highly flexible, compact and universal data logger for different types of measurement tasks? The Expert Logger is the optimal solution.

Expert Logger is available in four variants differing in their number of analog and digital channels. With just one device, you can independently process up to 46 analog input channels, at both low and high sampling rates. All channels are galvanically isolated from each other. Measured data undergoes precision recording, monitoring and preprocessing and can be stored internally within the device. LAN, USB, WLAN or UMTS / LTE are available to transfer measurement data to a PC or server. Integrated interfaces such as PROFIBUS, Modbus and OPC UA enable optimal connectivity to existing infrastructure.

The Expert Logger is highly flexible to meet your specific measurement requirements. Simple and quick channel configuration enables the Logger to be efficiently adapted to your requirements and can be up and running in the shortest possible time.



USB  
LAN  
WLAN / LTE

**Expert Logger**

Type	100	200	300	400
Analog inputs for mV, mA, thermocouples	16	32	46	16
Appropriate for RTD	8	16	23	8
Total sampling rates (measurements / sec.)	1000	2000	3000	1000
Analog outputs	0	0	0	6
Digital / frequency inputs	4	4	0	1
SDI-12 sensor bus	1	1	0	0
Digital / PWM outputs	4	4	0	0
Digital inputs / outputs	4	4	1	24



# uitive operation

## Applications

- Measurement data acquisition
- Environmental measurement technology
- Product testing
- Laboratory data acquisition
- Fault data acquisition
- Trials and testing
- Energy data acquisition and optimisation
- Remote data transmission
- Control

ProfiSignal

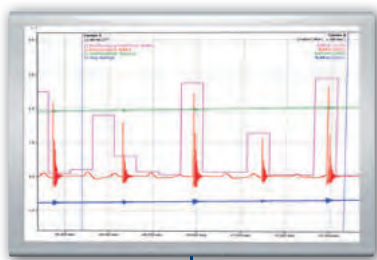

Data acquisition and analysis

## Input signals

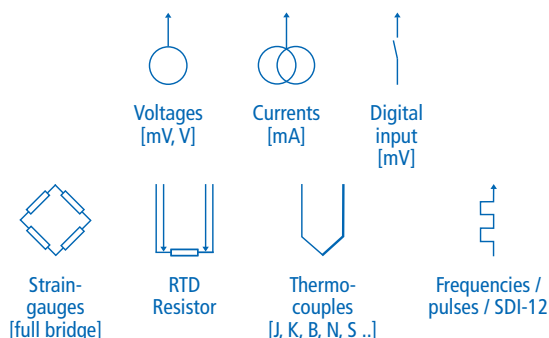

## Output signals

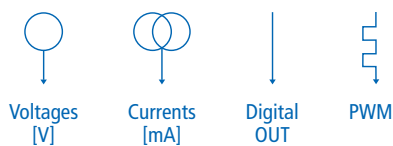

## Interfaces

- Modbus TCP/RTU
- PROFIBUS DP, CAN RAW
- RS232, RS485

- SDI-12
- OPC UA



## Product features

- Up to 46 universal analog inputs
- Up to 24 digital inputs and switching outputs
- Remote monitoring via a UMTS / LTE interface (optional)
- WLAN interface for wireless data transmission (optional)
- Automated email and textmessage alerts

## Sensor connection

- Universal analog inputs (mV, mA, thermocouples, RTD)
- Switch signals, frequency and pulse counters
- Pluggable screw terminals

## Interfaces / Protocols

- LAN, USB
- SDI12 interface for environmental sensors
- Serial interfaces RS232, RS485
- OPC UA, Modbus TCP/RTU
- PROFIBUS DP, CAN RAW
- Configuration of individual ASCII protocols
- NMEA for GPS sensors (optional)

## Internal / external data storage

- 2 GB or 14 GB internal storage
- External storage media (USB, NAS)
- Event-triggered recording with pre and post histories
- Push function

## Product highlights

- Universally usable inputs
- Software channels for analysis, monitoring, control and regulating
- Versatile interfaces
- High galvanic isolation voltage
- UMTS / LTE, WLAN, USB
- PROFIBUS Sniffer
- Many channels in a minimum of space
- 24-bit resolution and high-precision measurement
- External data storage

# Expert Transient – Synchronous **fault specialist**

Is your system causing problems again? Then it's time to make a change. The synchronous, autonomous acquisition of multiple universal channels using the Expert Transient enables you to precisely analyse processes over time and helps localise faults.

Expert Transient is suitable for acquiring and analysing fast, transient and sporadic signals as well as periodic and continuous processes. Speed is guaranteed by a high sampling rate of up to 50 kHz per channel and a high 24-bit resolution. Triggered data recording turns fault incidents into measurement data files, making evaluation much easier.

You can adapt the transient recorder to your specific needs – from basic limit value monitoring to characteristic value calculation – using its integrated software channels to process the measurement data independently of a PC. Serial interfaces enable connection to machine control systems. Data can also be transmitted via a bus system and recorded using a sniffer. To avoid feedback, all channels are galvanically isolated from each other as well as from the integrated interfaces.



WLAN

Expert Transient

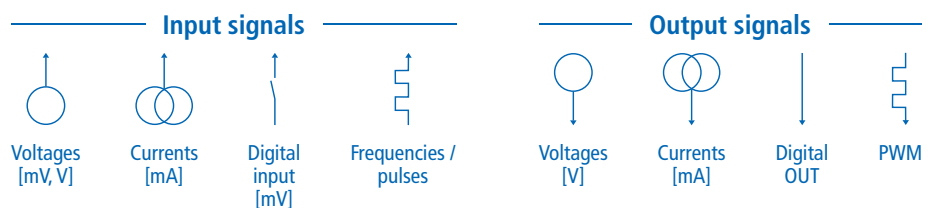

Type	4	8	12	16
Analog inputs (mV, mA)	4	8	12	16
Analog outputs (mV, mA)	4	4	4	4
Digital / frequency inputs	4	4	4	4
Digital outputs	8	8	8	8



## Applications

- Fault finding and analysis of PLC-based systems and machines without having to interrupt control systems
- Crash, detonation and explosion testing
- Fast data acquisition on test stands
- Data acquisition from drive systems and frequency converters
- Fault analysis on gas compressor plants, turbines, compressors and conveyor belts
- Materials research and environmental simulation

## ProfiSignal

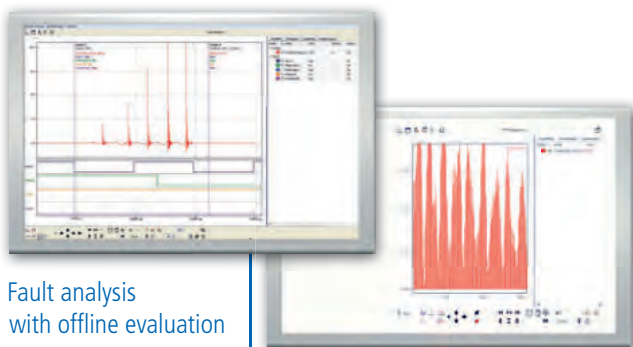

Fault analysis with offline evaluation

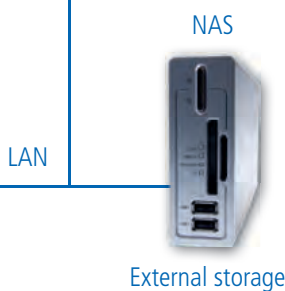

## Interfaces

- Modbus TCP/RTU
- PROFIBUS DP, CAN RAW
- RS232, RS485

- PROFIBUS Sniffer
- OPC UA



## Product features

- Synchronous acquisition of 4, 8, 12 or 16 galvanically isolated analog inputs
- Definable multiple, flexible trigger events
- Online calculation of effective and peak values
- 50 kHz sampling rate per channel
- 24-bit resolution and high-precision measurement
- Email and textmessage alerts
- Extendible

## Sensor connection

- mV / mA signals
- Measuring range up to  $\pm 25$  V
- Pluggable screw terminals

## Interfaces

- LAN, USB, WLAN (optional), LTE (optional)
- Serial interfaces RS232, RS485
- OPC UA, Modbus TCP/RTU
- PROFIBUS DP, CAN RAW
- PROFIBUS Sniffer
- Individual ASCII protocols

## Data storage

- Independent, internal 2 GB or 14 GB storage
- External storage media (USB, NAS)
- Triggered storage with pre and post histories

## Product highlights

- Acquisition and analysis of fast, transient signals
- 4, 8, 12 or 16 individually triggerable analog inputs
- Independent operation with long-term storage
- PROFIBUS Sniffer

# Expert Key – PC-based measurement technology

Correct measurement and acquisition of different measurement units is now possible. Easy operation and reliable performance are vital to make measurement a routine task, whether in laboratories, for servicing or at test stands.

With the Expert Key, we offer you a measuring system that, combined with a PC, provides the optimal basis for your measurement data requirements. A compact design gives it the flexibility to connect different sensor types. An ideal combination of analog and digital inputs makes the Expert Key ideal for test engineering. Whether you need to acquire slow or fast processes, Expert Key's sampling rate is adjustable channel by channel. This means you are not bound to one rate from the outset and can use the device for changing measuring requirements.

Setting sensor types, scaling and unique designations are performed via dialogs. You can then easily navigate the system while quickly setting channels and instantly commencing with your measurement tasks.



Expert Key

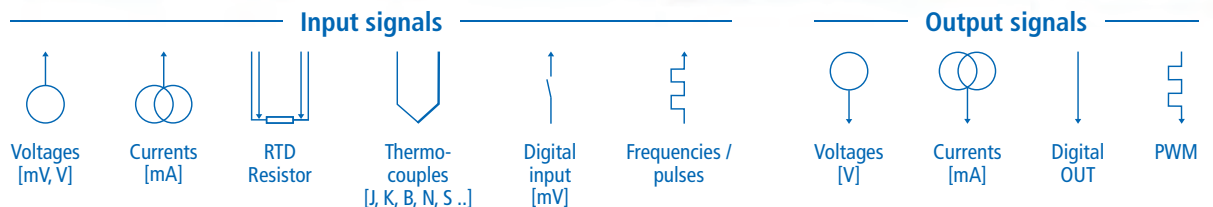

Type	100	200
Analog inputs (mV, mA, thermocouples, RTD)	14	28
Analog outputs (mV, mA)	2	2
Digital inputs (frequency, counter)*1	12	1
Digital outputs**2	8	1

\*1 4 switchable as digital outputs

\*\*2 4 with PWM function



# from laboratory to test stand

## Applications

- Automated trials, testing and inspection
- Laboratory data acquisition
- Fast signal acquisition
- Temperature acquisition
- Servicing and installation
- PC-supported data acquisition
- Monitoring and alerting

ProfiSignal

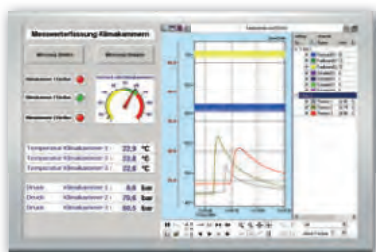

Data acquisition  
and analysis

LAN

USB

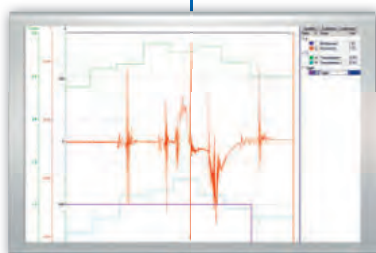

## Product features

- Optional 14 or 28 analog inputs
- Total sampling rate 100 kHz
- Universally usable inputs and outputs
- Simple scaling
- Configuration software included
- Different versions to match requirements
- Compact design, highly flexible

## Sensor connection

- Universal analog inputs (mV, mA, thermocouples, RTD)
- Digital inputs can also be used as frequency and pulse counters
- Pluggable screw terminals
- Clear connection diagram for simple wiring

## Interfaces

- LAN interface
- USB interface

## Data storage

- Data storage in PCs or on servers
- Intelligent database system included

## Versions

- Expert Key L – for laboratories and servicing
- Expert Key P – for trials and testing
- Expert Key C – for control cabinet construction
- Expert Key T – for multi-channel temperature measurements

## Product highlights

- Universal connection options
- Total sampling rate 100 kHz
- High precision due to differential sensor connection
- Simple configuration
- Fast connectivity via LAN or USB
- Detachable screw terminals or plug connectors for easy connection
- Reliable monitoring and alerting

# Loggito – The networking specialist

Are you looking for a device that is compact, high-precision and with a low number of inputs for decentralised measuring tasks? Industrial measurement technology in a compact design, or Loggito for short, is the answer.

Loggito is a compact measuring system that doesn't compromise on quality. You can use Loggito as a low-channel data logger or as part of a complex measuring network with distributed measuring points, fully tailored to your needs. It requires minimum space so is quick and easy to retrofit into your existing system(s). Loggito matches your needs.

The Loggito Logger is an autonomous data logger with internal measurement data storage capabilities. Integrated software channels enable easy configuration of monitoring and calculation procedures. The device has an extended range of possible applications.

The Loggito USB is an entry-level version in Delphin's measurement technology. Loggito USB can be used either for PC-based measurement or as an extension to the Loggito Logger.



Loggito Logger

Measurement technology at the edge



Loggito USB

Channel types	8 AI-R	8 AI	4 AI-R	4 AI
Analog inputs (mV, mA (passive), thermocouples, RTD)	8 (max. 4 RTD)	0	4 (max. 2 RTD)	0
Analog inputs (mV, mA (passive), thermocouples)	0	8	0	4
Digital inputs / outputs (Combination)	2	2	2	2
Number of terminals	24	24	16	16



## Applications

- Automated trials, testing and inspection
- Laboratory data acquisition
- Decentralised data acquisition
- Temperature acquisition
- Servicing and start-up
- Monitoring and alerting
- Mobile measuring

## ProfiSignal

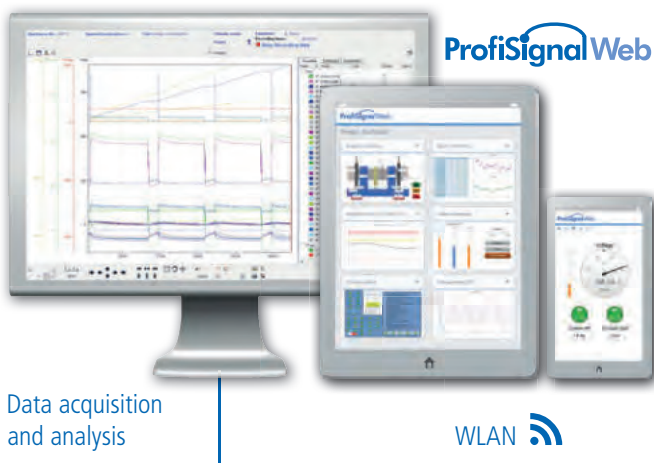

Data acquisition and analysis

USB / LAN

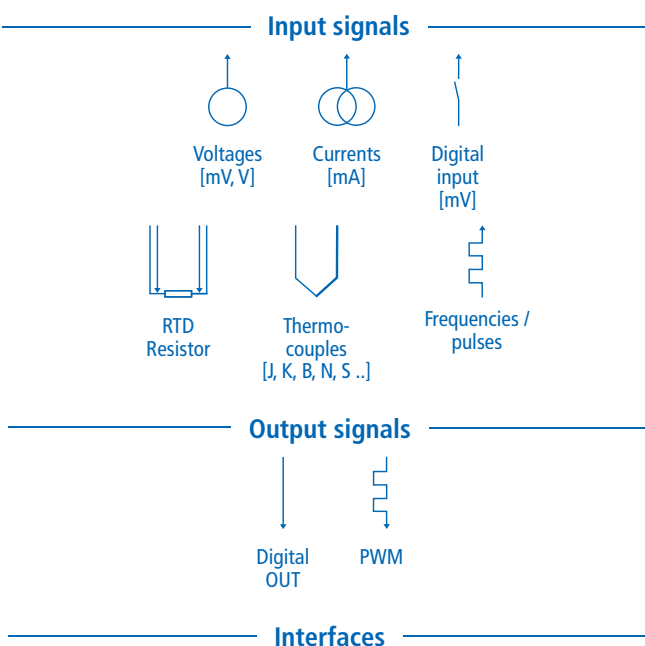

- Modbus TCP/RTU

- OPC UA



## Product features

- Up to 8 universal analog inputs
- Digital inputs or switching outputs
- Very compact
- Flexible sampling rate for a wide range of applications

## Sensor connection

- Universal analog inputs (mV, mA, thermocouples, optional RTD)
- Digital inputs can also be used as frequency and pulse counters
- Pluggable spring-clamp terminals
- Clear connection diagram for simple wiring

## Interfaces

- LAN interface (only with Loggito Logger)
- USB interface
- Modbus TCP (optional and only with Loggito Logger)
- OPC UA (optional and only with Loggito Logger)
- WLAN (optional and only with Loggito Logger)

## Data storage (Loggito Logger only)

- 4 or 8 GB internal storage
- External storage media (USB, NAS)
- Event-triggered recording with pre and post histories
- Push function

## Product highlights

- Very compact design
- Universal connection options
- High precision due to differential sensor connection
- Simple configuration
- Detachable spring-clamp terminals for easy connection
- Reliable monitoring and alerting

# LogMessage 5000 – Galvanic isolation at the high

Are you looking for testing technology for measurements on high electrical potential and avoidance of ground loops? Then the right solution is the LogMessage 5000.

Sensor types can be set individually for each channel in the LogMessage 5000 data logger enabling the device to be used universally. The inputs are designed to cope with high voltages between the individual channels. Measuring non-isolated signals presents no problems. The system is intuitive to use and only a few steps are required to configure inputs and store data. The device uses tried and tested software channels to enable signal preprocessing to be performed easily and directly within the device. Limit value channels, calculation channels and many other functions can then be quickly implemented to extend the device from a pure data logger to a full signal monitoring unit.

With its internal storage capability, you get a PC-independent data logger in a compact design that can be tailored to your specific requirements.



LogMessage 5000

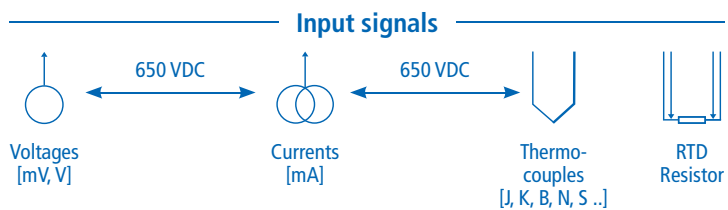



## Applications

- Potential affected measurements
- Autonomous and secure data acquisition
- Acquisition of universal sensor signals
- PC-independent measuring and testing
- Product testing, laboratories, R & D
- GPS data logging and remote monitoring
- Temperature measurement acquisition
- Mobile data acquisition for servicing

ProfiSignal

USB

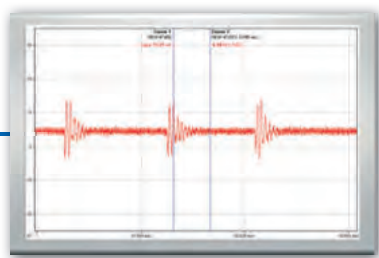

Offline

LAN



Online

## Interfaces

- Modbus TCP/RTU
- CAN RAW
- RS232, RS485

- OPC UA



## Product features

- 16 universal analog inputs
- Sampling rates from 0.1 Hz to 60 Hz
- All analog inputs are differential
- Up to a maximum of 650 VDC isolating voltages between analog inputs
- Galvanic isolation of supply voltage and all interfaces
- No ground-loop issues
- Online calculation of measured values

## Sensor connection

- Universal analog inputs (mV, mA, thermocouples, RTD)
- Clear connection diagram for simple wiring
- Screw terminals for universal sensor connection

## Interfaces

- LAN, USB
- Serial interfaces RS232, RS485
- OPC UA, Modbus TCP/RTU
- CAN RAW

## Data storage

- 2 GB or 14 GB internal storage
- External storage media (USB, NAS)
- Event-triggered recording with pre and post histories
- Push function

## Product highlights

- High-level galvanic isolation
- Universal connection options
- Simple configuration
- Fast connection via LAN
- Reliable monitoring and alerting
- 24-bit A/D converter

# Software Channels – Flexible and **autonomous**

Do you want to control your application in real-time independent from PC and network? Delphin's software channels provide tools to efficiently meet your needs.

Software channels are predefined function modules that are individually created, configured and processed by the user at a mouse click. For example, measurement data can undergo online processing using calculation channels. Limit value channels monitor measurement data and trigger alarms or send emails in the event of deviations. Experiment procedures can be fully configured using software channels, and undergo automatic processing.

The number of software channels available is practically unlimited. All functions are carried out autonomously by a powerful processor in the Delphin device and thus guarantee fully secure operation. By using software channels, data acquisition becomes a complete system for automation, monitoring and online analysis.



# monitoring

	Description	Application example
<b>Online analysis</b>		
 <b>Calculation channel</b>	Any number of channels can undergo calculations with each other, Functions include: basic arithmetic operations, trigonometry, binary and Boolean functions	Temperature difference between two input temperatures
 <b>Mean-value channel</b>	Calculates moving and triggered mean values	Mean of highly sensitive signals from thermocouples
 <b>Edge counter</b>	Counter for pulses (up, down and reset function)	Energy pulses to count kWh
 <b>Differentiator</b>	Calculates changes over time	Gravimetric dosing in laboratories
 <b>Integrator</b>	Numerical integration over time	Calculating volumes from flow rates
 <b>Summation channel</b>	Time-independent addition of measurement data	Totalling of analog measurement data
 <b>Linearisation</b>	Corrective calculations for non-linear sensors	Linearisation of application-specific PTC sensors
 <b>Operating hours</b>	Accumulates high-level time-points in digital signals in hours	Determining on / off time ratios for a machine
 <b>Statistics</b>	Calculates moving and triggered statistical values (min, max, variance, standard deviation)	Determining maximum values in an experiment
 <b>Stopwatch</b>	Times between two events	Determining switching times for valves and thermal switches
<b>Monitoring</b>		
 <b>Limit</b>	Generates an event when limit values exceeded (exceeds / falls short, persistence, hysteresis bandwidth monitoring)	Alarm when a bearing temperature is exceeded
 <b>Combined</b>	Generates alarms from multiple digital input channels	Alarm from different parts of a system are combined into one message
 <b>Wake-up</b>	Generates pulses according to absolute calendar times (once per day, week, month ...)	Determining daily production statistics
 <b>Status</b>	Evaluates status information in a measurement data and generates alarms	Alarms for wire breaks in an mA signal
 <b>System</b>	Displays system information (CPU load, memory utilisation ...)	Alarms for full data storage capacity
<b>Automation</b>		
 <b>Setpoint channel / sequencer</b>	Automatically executes setpoint curves with reset, hold and start triggers	Automatic management of chemical processes temperatures / stirrers
 <b>FlipFlop channel</b>	RS, JK, D FlipFlop	Storage of digital statuses and analog data for further processing
 <b>Pulse generator</b>	Generates cyclic pulses	Time synchronising every 15 min. Energy counter reset
 <b>Logic channel</b>	AND, OR, NOT, XOR, NOR ...	Boolean linking of any digital signal
 <b>Timer channel</b>	Functions for time elements (pick-up and drop-out delay)	Time-delayed starting of experiment procedures
 <b>Flag channel</b>	Stores constants and parameters	Process constants and control via GUI

# ProfiSignal – Intuitive **software** for measurement

Do you want to effortlessly visualise and analyse your measurement data, monitor your processes as well as create complex control systems without complex programming? ProfiSignal, the measurement technology software package, enables you to do so.

ProfiSignal is a complete software package for requirements in data acquisition and analysis, visualisation and automation. ProfiSignal is very user-friendly and combines a versatile range of functions with top-rate operability. Regardless of whether you want to process just a few or many thousands of channels, ProfiSignal is comprehensible and logically structured. Beginners can become quickly familiar with the software. ProfiSignal is modular, scalable and available in three versions: Go, Basic and Klicks. The higher level version has downward compatibility for operation, measurement files and application projects. The browser-based ProfiSignal Web is available for mobile and location-independent access to your processes.

Do you want to keep your measurement technology up to date and keep your investment safe? Keep on the safe side through rental licenses including updates and premium support.

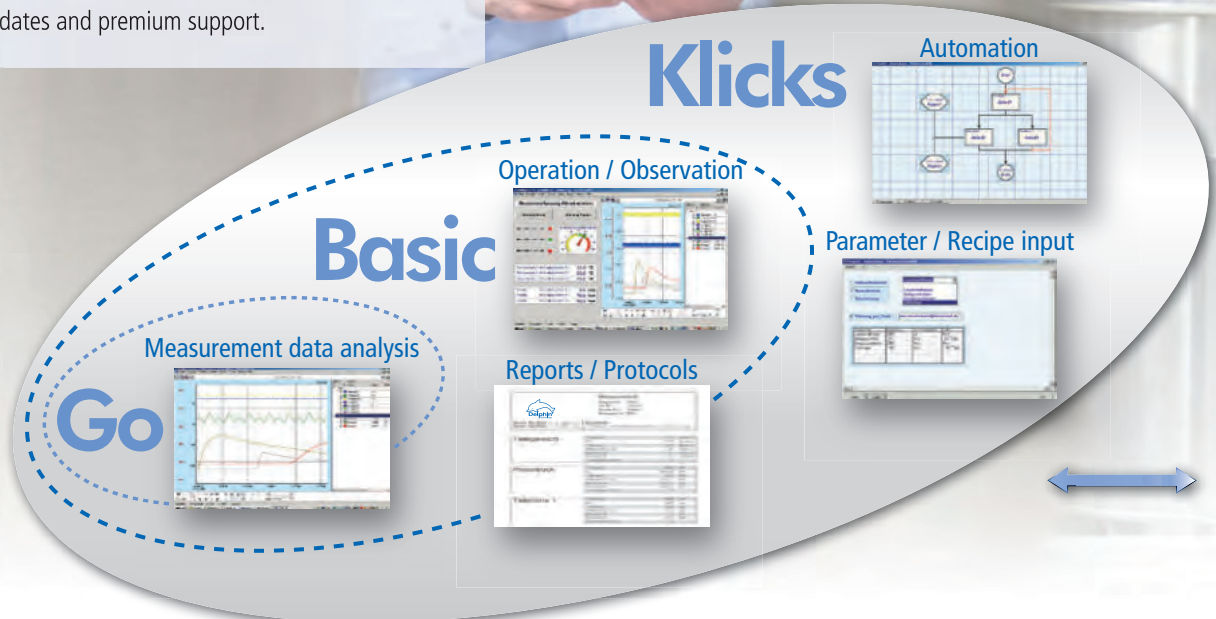

ProfiSignal Go	ProfiSignal Basic	ProfiSignal Klicks
Data acquisition	Monitoring	Automation
Process data acquisition and analysis	Condition monitoring of plant and machinery	Test stand automation with visualisation and operation
Laboratory data acquisition	Operation and process data acquisition	Process control
Start-up measurement data	Plant and machine monitoring	Test parameter and recipe management
Fault and fault data analysis	Energy data acquisition and visualisation	Automation of measurement tasks
Mobile and stationary data acquisition	Laboratory data acquisition and visualisation	Product development supported testing
Trials and tests	Clean room monitoring	Service life testing
Servicing measurements		Laboratory automation



# and testing technology



Using the new Delphin Data Center to move from single-workstation to centralised measurement data management, page 36.



## Web

Operation / Observation

Measurement data analysis



### ProfiSignalWeb

Web-based software

Condition monitoring of remote machines, systems and buildings

Mobile fault analysis

Field test installations

Weather-station and environmental measuring technology

Test drives

Maintenance and servicing

Checking inspection processes

### ProfiSignalGo

- Data acquisition and storage
- Measurement data analysis and calculation
- Online and offline trends
- Data export and printout

### ProfiSignalBasic

- Creation of system and process visualisation
- Operation and observing systems and processes
- Creation of basic reports

### ProfiSignalKlicks

- Automation of test stands
- Programming of control procedures
- Automation of evaluation / analysis functions
- Creation of parameter views
- Creation of detailed reports with automated evaluations

### ProfiSignalWeb

- Location-independent access to measurement data and processes
- Mobile process visualisation and control via customisable dashboards
- Display in the browsers of any end device

### Product highlights

- Diagrams for all applications
- Powerful measurement data display with quick and smooth transition between live and historical data
- Going from measurement data to diagram display in just three steps using ProfiSignal Go
- System and process visualisation with no programming effort required using ProfiSignal Basic
- Systems and process control with "programming by selection" using ProfiSignal Klicks
- Location and platform independent visualisation of measurement data and processes using ProfiSignal Web

# ProfiSignalGo – Just a few steps to go from **sensor**

Do you want to immediately begin recording and analysing measurement data? Then opt for the very easy-to-use ProfiSignal Go software.

ProfiSignal Go is Windows based software that requires just a few steps to visualise measurement data in a range of diagram types, as well as to monitor the data, analyse it, archive it as a file, and export it directly in ASCII format as a CSV file. During ongoing measuring, you can access historical measurement data without interrupting the current measuring process and thereby compare actual to past data. A range of cursor functions and flags are available to mark and process critical measurement data.

ProfiSignal Go is rounded off with statistical and online / offline calculation functions to facilitate test evaluations. Optional interfaces such as the OPC server / client, Modbus TCP and an open programming interface are also available to connect a wide variety of peripherals as well as Delphin's measurement and testing devices.

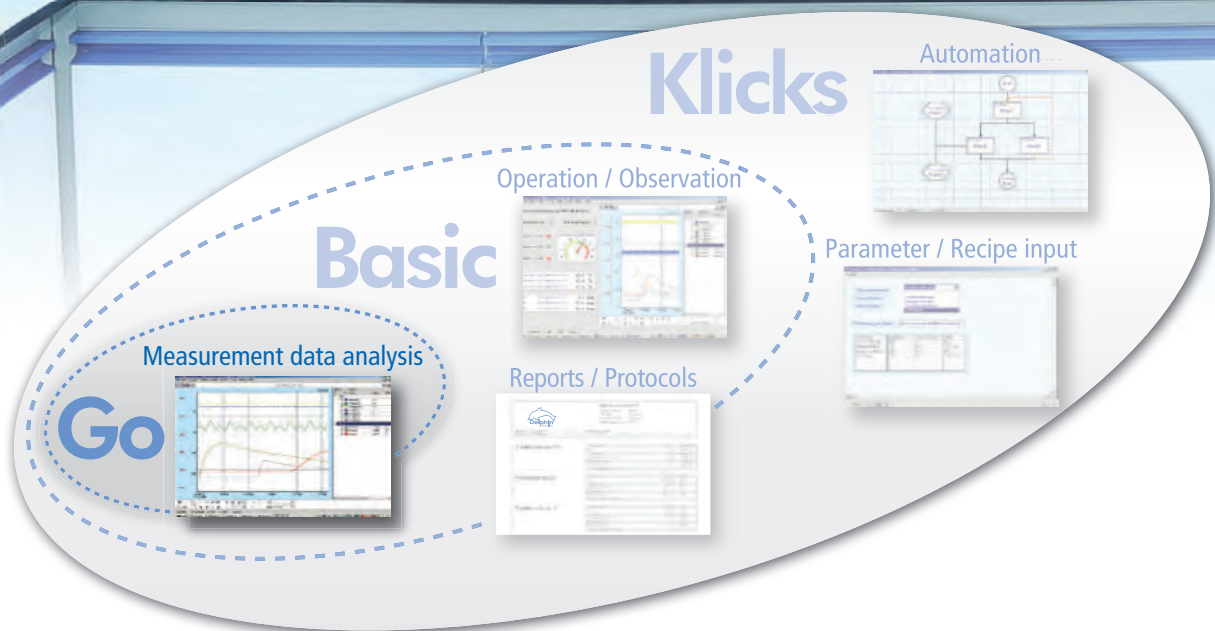



## Applications

- Process data acquisition and analysis
- Laboratory data acquisition
- Measuring during system installation
- Fault value analysis with recorder functions
- Mobile and stationary data acquisition
- Trials and testing
- Measuring for servicing and maintenance

## Product features

- Monitoring and analysis of any measured values
- Various diagram types for data visualisation (online / offline)
- Smooth switching from online to offline data
- ASCII export as CSV file / Trend export as vector-based EMF file
- Statistical and offline calculation functions
- Analysis using cursor functions down to  $\mu$ -second ranges
- Evaluation of digital signal sequences
- Permanent storage in database format
- Recording of batch-based tests to separate files
- Alert functions via email and fax
- Display of diagram functions

## Diagram types

- y(t) diagram
- y(x) diagram
- Characteristic curve diagram
- Oscilloscope diagram
- Digital logic diagram

## Interfaces and options

Further information can be found on pages 38, 40.

## Product highlights

- Simple operation from measurement data to trend
- Monitoring and analysis of any measurement data from any source (hardware and software)
- Many diagram types available
- Versatile interfaces for connecting peripherals
- Statistical evaluation and offline calculation functions
- From a general overview to high-resolution  $\mu$ sec ranges in just a few steps
- Direct export as CSV file or trend export as EMF file
- Up to four y-axes are possible to enable different measurement units in one diagram

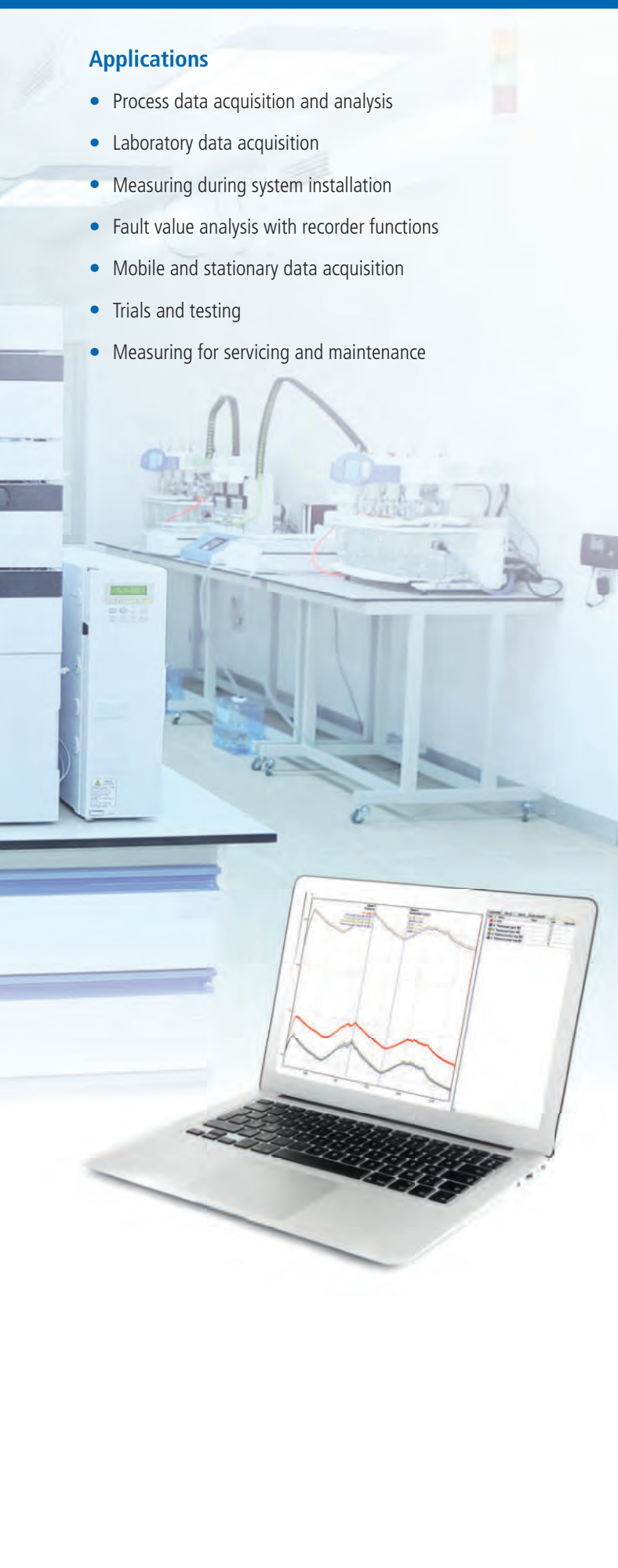

# ProfiSignal Basic – Visualisation and operation

Do you need a simple solution for monitoring applications and process visualisation? Then ProfiSignal Basic is the right choice.

ProfiSignal Basic is a complete software package that enables you to create individual diagrams using a wide range of operating and monitoring objects. Both continuous processes (e.g. operational data acquisition) and noncontinuous measuring tasks (e.g. test measurements) can be visualised, operated and monitored without any programming effort. The operating and monitoring diagrams are simply created by combining and configuring elements. Pre-configured basic functions are available for operating test stands and automating measurement tasks.

For logging purposes, basic reports, e.g. with header data, diagrams and annotation fields, can be created on a time-controlled basis.

ProfiSignal Basic includes all ProfiSignal Go features and its many diagram types, and archiving and export tools, to provide your applications with a wide range of functions.

**Klicks**

Automation

Parameter / Recipe input

Operation / Observation

**Basic**

Measurement data analysis

Reports / Protocols

**Go**

The complex block features a large, light-colored oval graphic that serves as a container for various software interface elements. At the top left of the oval is the word "Klicks" in a blue, sans-serif font. Below it, the word "Automation" is written in a smaller font above a small flowchart diagram. To the right, "Parameter / Recipe input" is written above a screenshot of a data entry form. In the center, "Operation / Observation" is written above a screenshot of a monitoring dashboard with multiple graphs and data points. Below that, "Reports / Protocols" is written above a screenshot of a report template with various fields and a logo. To the left, "Measurement data analysis" is written above a screenshot of a data analysis graph. The word "Basic" is prominently displayed in a large, blue, sans-serif font in the middle of the oval. At the bottom left, the word "Go" is written in a large, light blue, sans-serif font. The entire graphic is set against a background of an industrial plant with tall distillation columns and complex piping, set against a sunset sky.



## Applications

- Condition monitoring
- Operational and process data acquisition
- Trials and testing
- Systems and machine monitoring
- Energy data acquisition and monitoring
- Acquisition and visualisation of laboratory data
- Clean room monitoring

## Product features

- Multiprocessing – independent execution of multiple applications
- Versatile operating and monitoring functions
- Base functions for automation
- Monitoring and analysis of any measured values
- Reporting

## Operating and observation objects

- Buttons, slide and toggle switches
- Input fields, dropdown lists and check boxes
- Analog and digital displays, signal lamps
- Tanks
- Tables
- Images for customised design
- Background images e.g. system schematics, drawings, photos

## Diagram types

- y(t) diagram
- y(x) diagram
- Characteristic curve diagrams
- Digital logic analysis
- Oscilloscope diagram

## Interfaces and options

Further information can be found on pages 38, 40.

## Product highlights

- Intuitive creation of diagrams without programming
- Includes preconfigured operating and monitoring elements
- Optimally usable both for the monitoring of continuous processes and for batch and experiment measurements
- Basic functions for automation available
- Report generation



ProfiSignal with a Basic visualisation

# ProfiSignal Klicks – The **complete package** with

Do you want to be able to automate your experiments and measurement needs independently from programming experts and without requiring programming expertise? Then use the unique development environment of ProfiSignal Klicks and create your applications using “programming by selection”!

ProfiSignal Klicks was developed by engineers for engineers. Without extensive training and with the aid of ready-made context menus and program texts, Klicks allows you to automatically create applications including visualisation and process flow control. As a user, learning a programming language is not required. A structure view enables you to structure each step in your application in a clear and interconnected way, so you always keep an overview. The creation of individual reports, which can be automated according to your test procedure, considerably reduces documentation effort.

ProfiSignal Klicks is the complete software package and contains all the functions from ProfiSignal Go and ProfiSignal Basic.





# all options

## Applications

- Test stand automation with visualisation and operation
- Creation of process controls
- Management of test parameters and recipes
- Laboratory automation
- Product testing
- Automation of measuring tasks

## Product features

- Automation functions through ready-made context menus and program texts
- Creation of recipes and management of test parameters
- Versatile operating and monitoring functions
- Synchronous / asynchronous execution of multiple applications through multiprocessing
- SQL interface for database connection
- Creation of detailed, individualised reports

## Operating and observation objects

- Buttons, slide and toggle switches
- Input fields, dropdown lists and check boxes
- Analog and digital displays, signal lamps
- Tanks
- Tables
- Images for customised design
- Background images e.g. system schematics, drawings, photos

## Diagram types

- $y(t)$  diagram
- $y(x)$  diagram
- Characteristic curve diagram
- Digital logic analysis
- Oscilloscope diagram

## Interfaces and options

Further information can be found on pages 38, 40.

## Product highlights

- Complete software for visualisation, automation and operation of a full range of measuring and testing requirements
- “programming by selection” – automate processes and test tasks without a programming language
- Clear structure diagram simplifies maintenance of the application
- Automatic generation of detailed, individualised reports
- SQL interface available for connecting to databases

# ProfiSignalWeb – **Web-based** visualisation and op

Do you want to acquire globally distributed data and visualise it on a tablet or smartphone regardless of your location? Do you need a way to instantly check the current operating parameters of a system or machine using your mobile device? Then ProfiSignal Web is the professional solution for the mobile visualisation of measurement data and processes.

The ProfiSignal Web client server software monitors, observes and controls your processes worldwide and location-independently. You can compile your individual diagrams from many display types and control elements. Measurement data is visualised in performance-optimised  $y(t)$  diagrams that enable smooth back and forth scrolling between live and historical data. No installation is required on your mobile device; viewing takes place simply in any browser.

Your measurement data and projects are accessed and stored either directly from a Delphin device used for data acquisition or from a central server.



**Web** Operation / Observation

Measurement data analysis





## Applications

- Field test installations
- Mobile fault analysis
- Condition monitoring of remote machines, systems and buildings
- Weather-station and environmental measuring technology
- Test drives
- Maintenance and repair
- Control of inspection processes

## Product features

- Client server application for creating basic and complex process visualisations with individually created dashboards
- Running and storing data in the measuring device, local PCs, in the cloud or in a company intranet
- No installation of the web frontend required; run in a browser
- Multi-user concept; several clients can access the same project
- Control access rights and manage users

## Diagram types

- y(t) diagram
- Multiple independent y-axes per diagram
- Zoom functions
- Print function

## Graphical display elements

- Analog instruments as bar, circular and tachometers
- Digital displays and signal lamps
- Geometric objects (circles, rectangles etc.)

## Operating and control elements

- Buttons and slide switches
- Text input fields

## Interfaces

Further information can be found on page 38.

## Product highlights

- Mobile process visualisation and control via quick to create individualised dashboards
- High-performance display of current and historical measurement data in multi-axis y(t) diagrams
- Web server installation and data storage directly in the device or on any server
- No web client installation required
- Advanced multi-user concept
- Modern design and intuitive operation



# Delphin Data Center – Centralised measurement

How are your measurement requirements changing in the face of Industry 4.0 and IIoT? Are many of your measurement application isolated systems? Is measurement data being stored in different formats and different platforms? With the Delphin Data Center, you now have a solution which enables you to set up your own measurement data management without time-consuming and costly programming.

Cross-process data processing and analysis is often tedious and involves extensive manual effort or extensive programming work. Usually no uniform data structure exists, especially in machine parks that have developed over time. The Delphin Data Center brings together and synchronises data from different sources. The Delphin Data Center's open structure creates a central data pool to enable you to standardise, archive and monitor measurement and process data in a simple way. A wide range of applications can then be implemented for inspection requirements, life cycle testing, the monitoring of systems and machines, locally or worldwide.

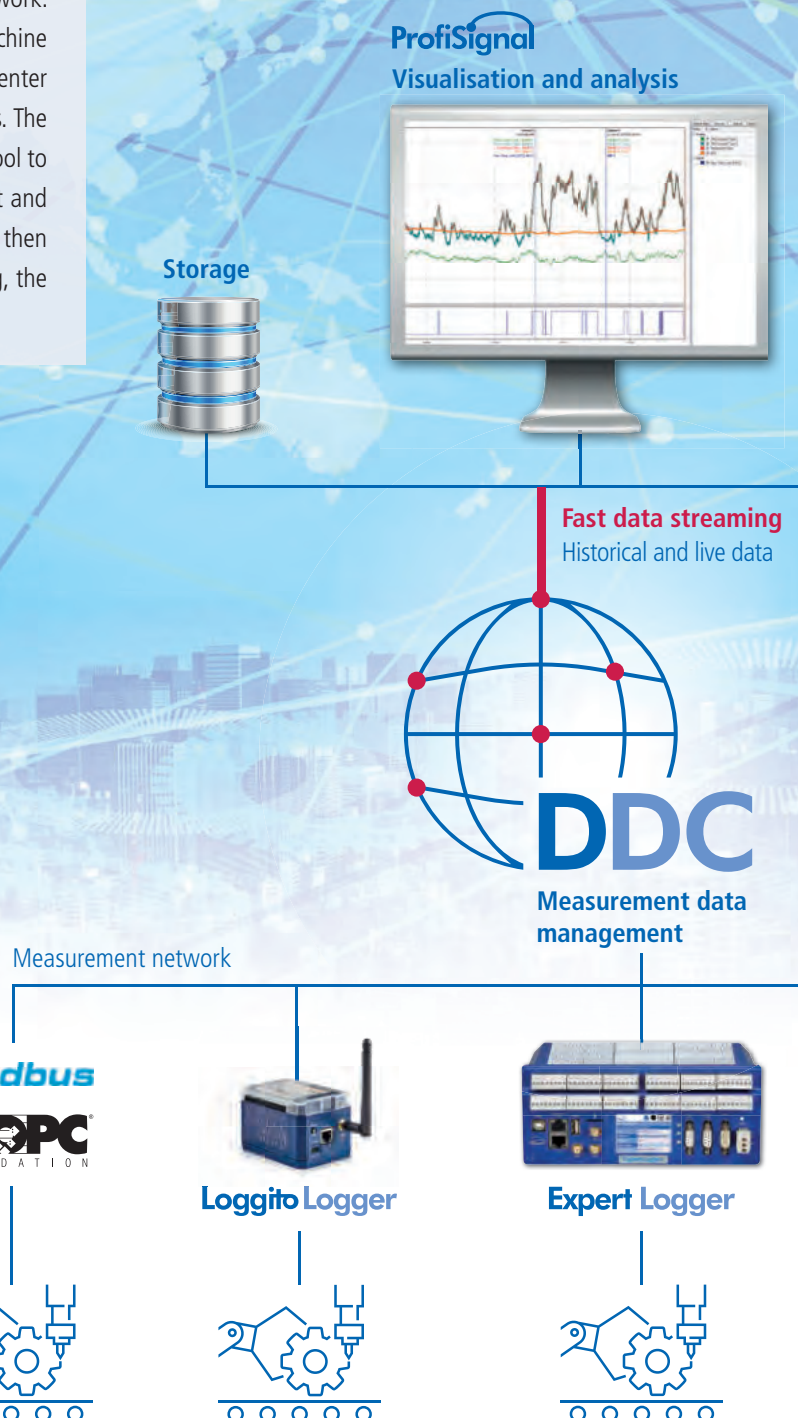



# data management

## Applications

- Condition monitoring of machines and systems
- Operational and process data acquisition
- Service life testing and long-term archiving
- Synchronisation of worldwide measurement / monitoring tasks
- Data standardisation and conversion
- FDA-compliant applications / clean room monitoring

## ProfiSignalWeb Worldwide distribution



## Monitoring and alerting



## Data management

- Centralised data collection from distributed sources
- Continuous and batch-based archiving
- Loss-free compression algorithms
- Lightning fast access from ms to yearly viewing
- Special data preprocessing via software channels
- Smooth transition from online to historical data
- Access via any number of clients (license packages)

## Alarm management

- Create alarm conditions and rules
- Detailed alarm list with options for confirmation
- Notification by email and text messaging
- Audit trail for FDA compliant applications

## User management

- Password management
- Management of user rights
- Client management

## Data interfaces

- OPC DA Client / Server
- Modbus TCP Master / Slave
- ASCII/DLL
- API interface
- SQL interface and ODBC
- Individual drivers incl. configuration dialogs

## Product highlights

- Easy to use, implementation without programming
- High-performance data archiving with lightning-fast access
- Loss-free data compression
- Extendible via web servers for platform-independent access
- Processing of up to 10 million data records per second



Expert Vibro

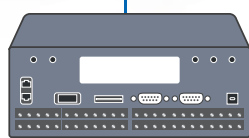

Third-party hardware  
OPC UA, SPS/PLC, Modbus TCP Server

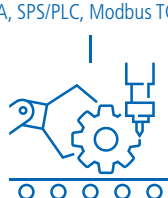

# ProfiSignal – Interfaces, Runtime, Viewer

Do you want to connect external software and hardware to your ProfiSignal application, perform finished projects without a development environment, or analyse measurement files and reports offline? We have the solution.

Drivers for high-speed data transfers are available for exchanging data with third-party software and hardware. You can use ProfiSignal to connect sensors and other control and measurement systems via a variety of interfaces. An API interface enables ProfiSignal to also be integrated into higher level programming languages.

Once a ProfiSignal project has been developed, it can be easily performed with a Runtime license without the possibility to make any changes to the application. The Runtime version contains all the ProfiSignal options available in the development version.

The ProfiSignal Viewer allows you to perform offline analysis of measurement data and reports created with ProfiSignal. It is ideal when measurement data is to be analysed and exported only and no applications or online data are required.

## Product highlights

- **ProfiSignal interfaces:**  
A broad range of interfaces for connecting third-party software and hardware
- **ProfiSignal Runtime:**  
Tamper-proof execution of ProfiSignal projects
- **ProfiSignal Viewer:**  
Easy offline analysis of measurement data





## Applications

- **ProfiSignal interfaces:** Connection of third-party software and hardware and data exchange with ProfiSignal applications
- **ProfiSignal-Runtime:** Performing completed ProfiSignal projects without a development environment
- **ProfiSignal-Viewer:** Offline analysis of measurement data and reports created with ProfiSignal

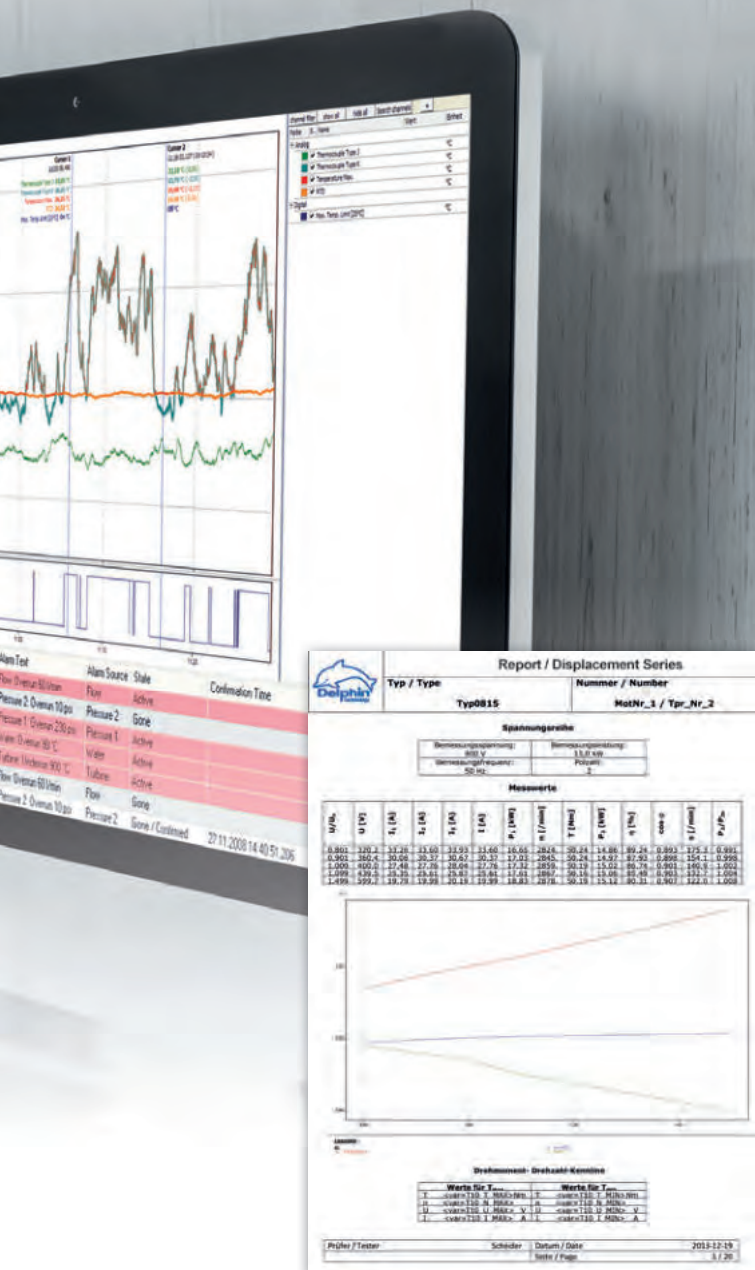

Excerpt of a report complying to QM-standard

## ProfiSignal interfaces features

- Driver for high-speed data exchange with NI LabVIEW, DASYLab and Diadem
- Connection of sensors or other control and measuring systems via OPC server / client and Modbus TCP
- Integration of ProfiSignal into higher programming languages via OCX or .NET interface
- Driver for integrating third-party hardware from the following manufacturers: VXI, PSI, HBM, WinSocket and many others
- Support of the fastest transmission rates
- Compatible with the latest software versions
- Easy to install
- Good documentation

## ProfiSignal Runtime features

- Tamper-proof execution of ProfiSignal projects
- Projects use only one file
- Easy duplication of the application on other PCs
- Cost-effective solution for OEM applications
- No development environment necessary

## ProfiSignal Viewer features

- Offline analysis and export of measurement data offline, e.g. in ASCII format
- Offline analysis and editing of reports
- Many diagrams, e.g. trend, characteristic curves, orbit, FFT diagrams
- All diagram functions, e.g. cursor, export, flag, statistics etc.
- No rigid documents, all measurement data with time stamp included in reports
- Displaying and editing of reports
- PDF print function

# ProfiSignal – Options

Do you have a vibration measurement application or do you have special requirements regarding validation, alarm management or data exchange? Then add the relevant option to your ProfiSignal package.

The Vibro option supplements existing ProfiSignal functions with special diagrams for vibration measurement, FFT, cascade, time signal, Bode diagram, envelope as well as orbit and spectrogram.

The Audittrail / FDA option provides functions in ProfiSignal Basic or Klicks for validating monitoring applications according to the FDA 21 CFR Part 11 guidelines.

The AlarmManagement option supplements ProfiSignal Basic or Klicks with important functions for monitoring and alerting.

The SQL option connects ProfiSignal measurement data with company and product databases as well as ERP systems (only for ProfiSignal Klicks).

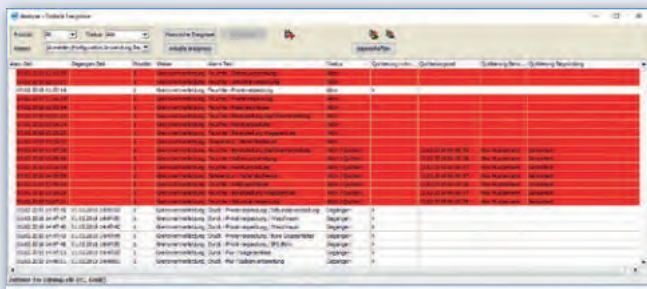

Alarm No.	Alarm Text	Source	Unit	Category	Priority	Current Status	Alarm History	Alarm Reporting
0000000001	Temperature too high	Temperature	Unit 1	Temperature	High	Active	2023-10-27 10:00:00	Active
0000000002	Pressure too low	Pressure	Unit 2	Pressure	Low	Active	2023-10-27 10:00:00	Active
0000000003	Vibration too high	Vibration	Unit 3	Vibration	High	Active	2023-10-27 10:00:00	Active
0000000004	Oil level too low	Oil Level	Unit 4	Oil Level	Low	Active	2023-10-27 10:00:00	Active
0000000005	Motor speed too high	Motor Speed	Unit 5	Motor Speed	High	Active	2023-10-27 10:00:00	Active
0000000006	Motor speed too low	Motor Speed	Unit 5	Motor Speed	Low	Active	2023-10-27 10:00:00	Active
0000000007	Motor current too high	Motor Current	Unit 5	Motor Current	High	Active	2023-10-27 10:00:00	Active
0000000008	Motor current too low	Motor Current	Unit 5	Motor Current	Low	Active	2023-10-27 10:00:00	Active
0000000009	Motor temperature too high	Motor Temperature	Unit 5	Motor Temperature	High	Active	2023-10-27 10:00:00	Active
0000000010	Motor temperature too low	Motor Temperature	Unit 5	Motor Temperature	Low	Active	2023-10-27 10:00:00	Active

Alarm table

## Applications

- **Vibro option:** Shaft vibration diagnosis and monitoring of gas / steam or hydropower turbines, compressors and drives as well as bearing vibration monitoring and roller bearing diagnosis on electric drives and rollers
- **Audittrail / FDA option:** Monitoring of applications requiring validation according to FDA 21 CFR Part 11 and data integrity through tamper-proof measurement databases
- **AlarmManagement option:** Applications with extra requirements for alarm management
- **SQL option:** Applications requiring connections to a company database or ERP system

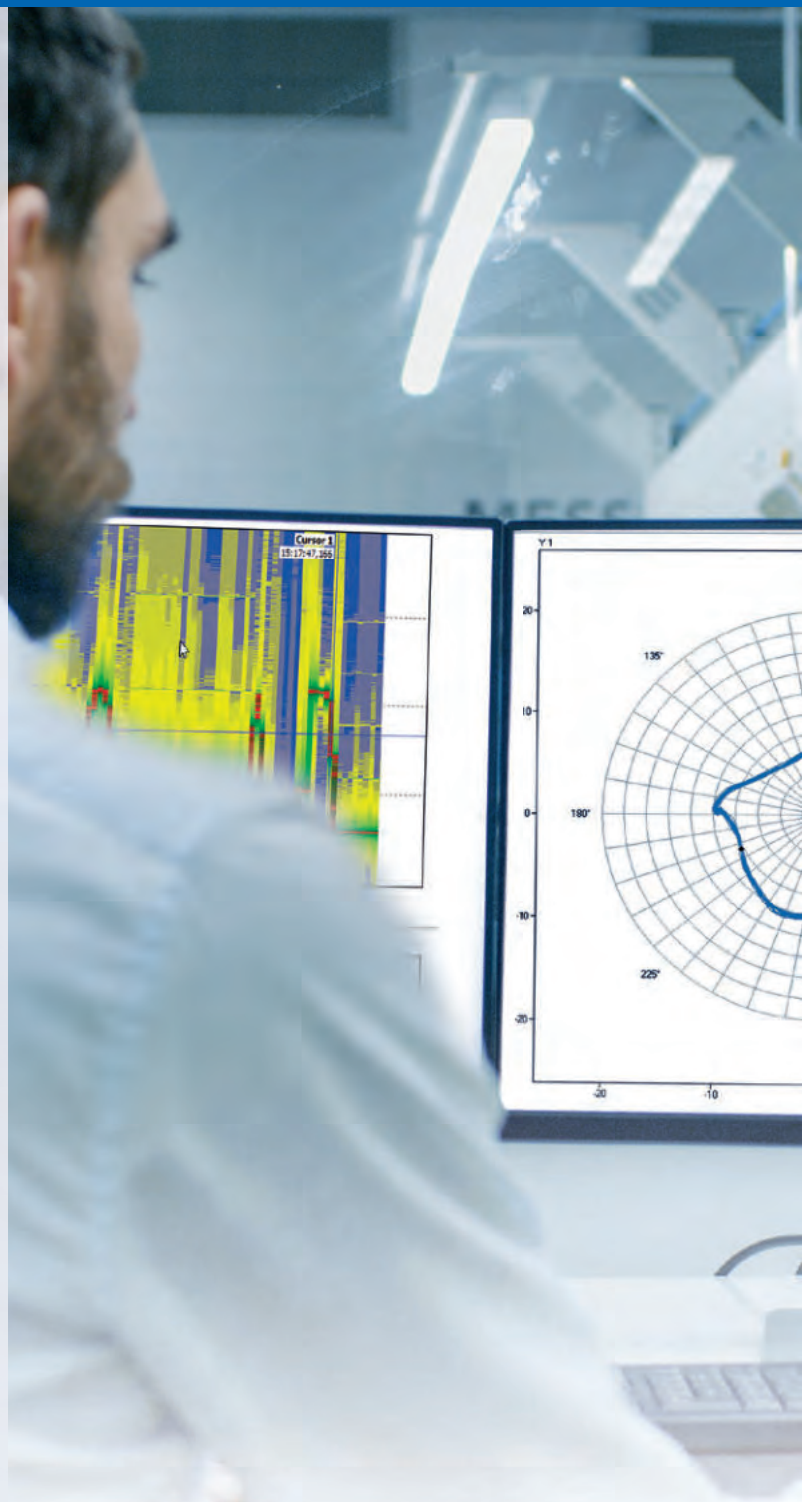



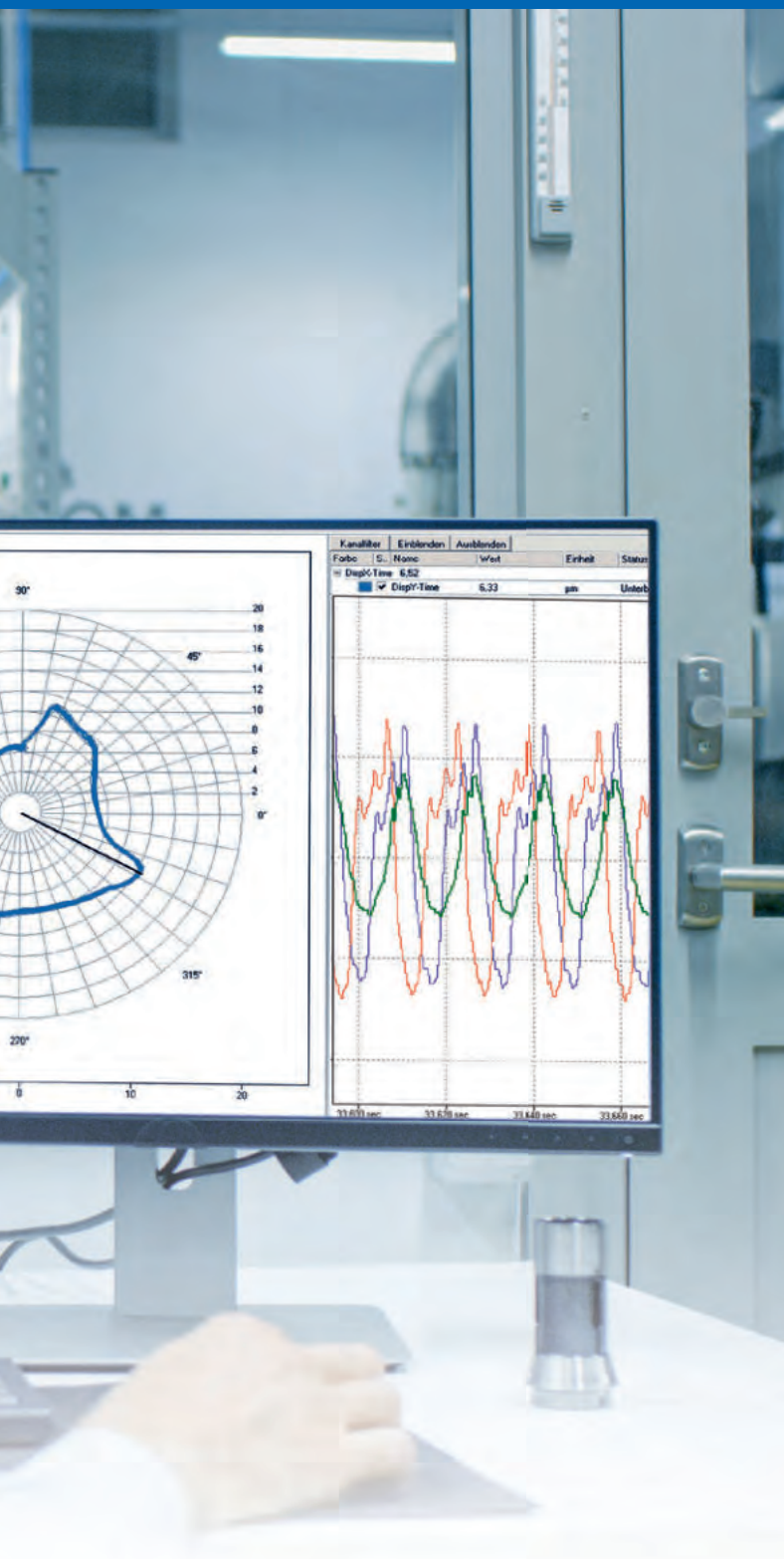

### Vibro option features

- Addition to ProfiSignal of special vibration measurement diagrams time signal, orbit, shaft centerline, polar, FFT, envelope, cascade, order analysis, spectrogram and bode
- On / offline display, evaluation of data measured with Expert Vibro
- Acquisition, visualisation and analysis of process and vibration measurement data in one system
- Documentation of vibration data via a report generator with access to all special diagrams

### Audittrail / FDA option features

- User management with different authorisation levels
- Integrated alarm management with rights-dependent access to alarm lists and alarm confirmations with comments only
- Redundant tamper-proof archiving of measurement data on a server as well as directly within the acquisition hardware
- Logging of user interventions (according to user management) for hardware configuration changes as well as software changes and operating control elements on a PC (Audittrail)
- Regular automatic report generation on recorded measurement data, alarm incidents and user interventions

### AlarmManagement option features

- Structured creation of alarms and alarm classes
- Alarm recording with date and time, accurate to the millisecond
- Continuous logging of alarms in a separate alarm archive
- Extensive filter functions
- Analysis and access to both online and historical data with direct access to an alarm including pre- and post-alarm histories

### SQL option features

- Integration of an SQL interface for data exchange with other databases, e.g. for test sample parameters
- Connection to ProfiSignal via ODBC functionality to enable reading / writing of data

# Complete systems

## Measuring case

The measuring case combines the advantages of Delphin's renowned measuring and testing equipment with those of mobile data acquisition. Each measuring case is made individually according to requirements. Typical applications for the measuring cases include fault data acquisition, energy data acquisition, vibration analysis, quality assurance, servicing and installation.

All Delphin measuring and testing devices are available as mobile measuring cases. The robust design of the durable synthetic and aluminium cases guarantee a high level of safety. All existing connections and interfaces are wired to a front panel with engraved labelling. The type of connections (laboratory sockets, screw, terminals etc.) can be selected as required.

## Product highlights

- Mobile and PC-independent data acquisition
- Configurable assembly as required with analog and digital inputs and outputs
- Universal differential analog inputs for precision measurements with no transducers required
- Up to 50 kHz sampling rate per channel – internal, external storage capabilities possible
- Event-triggered storage with pre and post histories
- Simultaneous recording of vibration and process measurement data
- Remote connection of the measuring case via UMTS / LTE or internet
- Extended functions via external hardware such as power meters





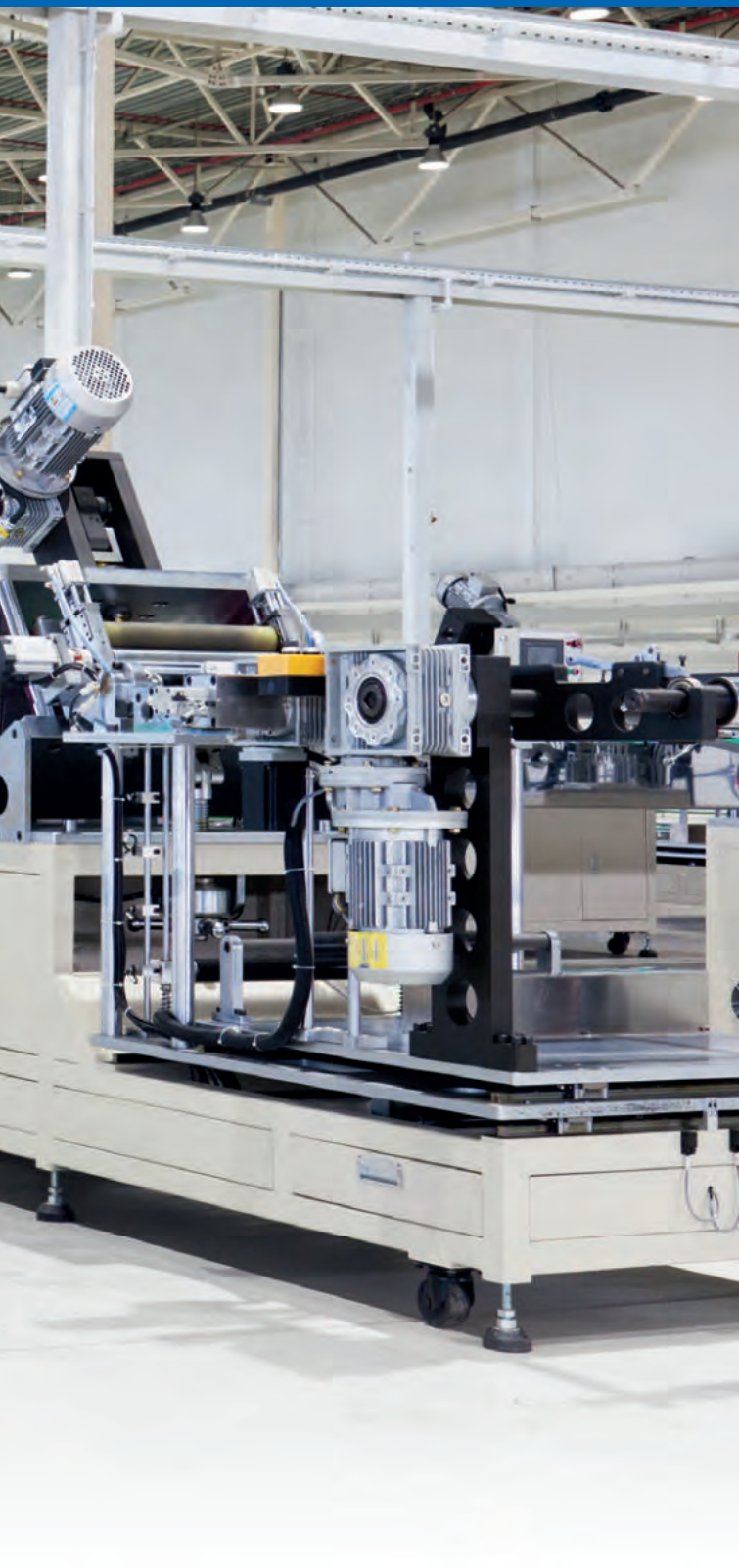

## 19" systems / control cabinets

Special tasks in testing, measuring and automation often require special hardware solutions tailored to the specific task.

Thanks to our many years of experience in the development of solutions for specific industries and applications, we are also able to provide special systems in 19" technology and / or control cabinet solutions. Every 19" system and every control cabinet is individually constructed according to your wishes and technical requirements.

In addition to Delphin components as measuring and control equipment, other components and external devices can also be integrated into the control cabinet.



## Product highlights

- Special solutions including hardware from a single source
- Professional design, from the mounting plate to the front panel
- Individualised connection technology
- Optional terminal or connector technology to connect sensors and actuators
- Expert engineering in the creation of your individualised assembly
- The customer approves the layouts and drawings prior to construction
- Compliance with all relevant safety standards, e.g. DIN VDE 0100, 0701, 0702
- Full functional testing

# Complete systems

## Universal testing device

Are you planning to perform a wide range of measurement and automation tasks, e.g. for laboratories or testing? Do you want to directly connect thermocouples, RTDs and other sensors and measure electrical AC/DC values? With the universal testing device, you have found the right solution. The device can also be used to automate testing tasks by means of switching and analog outputs. Integrated data storage enables the device to perform measurement and control tasks fully autonomously and independently of PCs.

The device is particularly suited to testing electro-technical products such as luminaires, lamps, kitchen appliances and electrical tools. Easy channel configuration using the included DataService / Configurator software means you can begin measuring within minutes.



Front and back of a universal testing device

## Product highlights

- Operation possible from the workplace via an integrated LAN interface
- Compact design in a 19" desktop housing
- Differential and galvanically isolated universal analog inputs
- AC/DC current, voltage and power measurement
- Switching and analog outputs for automation of test procedures
- Internal data storage of up to 14 GB
- Versatile internal setpoint, calculation and logic channels
- Connection of external hardware via serial interfaces
- Various drivers available: OCX (API), OPC, LabVIEW, DASyLab







## 64-channel thermocouple measurement device

Are you looking for a high-precision measuring device for measuring temperatures via thermocouples? With the 64-channel thermocouple measurement device, a system has been developed to meet the multi-channel measurement requirements in research and development as well as for laboratories and test stand set-ups.

The system can be used for measurement requirements in the development of gas turbines, boilers, furnaces and combustion plants. During the development of the 64-channel device, special emphasis was placed on optimum cold junction compensation and high precision. The device is easy to configure via a LAN interface using the included DataService / Configurator software. You can then begin measuring within just a few minutes.

The entire system meets the highest security requirements through redundant data storage and archiving. If required, password protection and user management is also available.



Front and back of a 64-channel thermocouple measurement device

### Product highlights

- 64 channels for thermocouples of types B, C, E, J, K, L, N, R, S, T, U
- Typical measuring accuracy of up to 0.2 K absolute
- 14 GB data storage for up to 70 days of autonomous operation
- Simple channel configuration using the DataService / Configurator via a LAN interface
- Upgradable to over 5,000 measuring channels by using 64-channel slave devices with the same housing type
- Secured against data loss through redundant data storage and archiving

# Solutions for industries – Chemicals, pharmaceu

You know that developing a technical product today involves a multitude of tests which, on the one hand, provide quality-related information and, on the other hand, need to document compliance on safety and standards. The norms, standards and guidelines setting down the tests and evaluations that need to be performed, offer a high potential for automation. We have many years of experience in the development of industry-specific complete solutions, so we are able to offer you tailor-made solutions for your individual requirements.

## Chemicals, pharmaceuticals, plastics

Setting up and testing measuring systems is not easy. The demand for preconfigured and complete measurement and test solutions is therefore high. At the same time, regulatory requirements are increasing. Measurement technology must also meet stringent specifications and are required to provide detailed proof and documentation, including full traceability.

## Application highlights

- Hardware, software, engineering, installation and training – all from a single source
- Fast and intuitive (re)configuration of measurement and test technology as well as the easy input of recipes for series tests, without requiring previous measurement technology expertise
- Easy connection to central control systems via interfaces to SQL databases, and open standards such as OPC UA
- Simple attachment of laboratory equipment from different manufacturers via a range of interfaces such as Modbus, PROFIBUS or OPC
- Tamper-proof recording of measurement data with unique time and data stamp as well as encrypted and secure data transmission and storage
- Alarm function with direct access to historical alarm data for pre and post alarm history analysis
- Detailed reporting functions for customised reports to document measurement data, alarm lists, user intervention and limit violations





# ticals, plastics and mechanical engineering



## Mechanical engineering

Increasingly complex systems and controls raise the demands on data acquisition and fault analysis. Systems are becoming increasingly connected and more intensively monitored with large volumes of data needing to be analysed in real time for services such as predictive maintenance. The need for intelligent measurement and test solutions and the demand for efficient complete solutions is increasing.



**You can find more solutions for industries:**  
[www.delphin.com](http://www.delphin.com)

## Application highlights

- Turnkey systems to guarantee fast availability, optimum controllability and reliable operation
- Data acquisition and monitoring in an intelligent system with quick and easy configuration and short set-up times
- Flexibility from having diverse (fieldbus) interfaces and support for open standards such as OPC UA
- Autonomous operation guarantees reliable data acquisition and storage with time stamps, even in the event of PC or network failures
- Integrated signal conditioning in place of external transducers
- Acquisition and evaluation of measurement data, automation and visualisation of measurement procedures and processes, automated report generation – all without requiring programming expertise
- Simple creation of system monitoring with a range of alarm options as well as fault value analysis with pre and post triggering

# Solutions for industries – Energy technology



## Energy technology

Increasingly more people want the option of using alternative energy sources. Research and development is therefore being carried out in many places such as at test stands and in large installations. Delphin products provide precisely the functions required in energy technology and are contributing significantly to productive testing, systematic fault finding, and safe and effective process monitoring.

## Application highlights

- Precise and fast measurement of different types of sensor signals ranging from temperatures, voltages and currents through to vibration signals
- Simple connection to control systems via various fieldbuses
- Isolation of channels, e.g. for measurements on fuel cells or batteries
- Internal data storage for autonomous measuring
- Monitoring and automation of test stand processes
- Effective evaluation also for extended time periods due to a long-term stable measurement database
- Simple to use cause analysis through precise event analysis sequencing
- Remote monitoring options for access from anywhere in the world



# Heating, air-conditioning, ventilation

## Heating, air-conditioning, ventilation

To comply with the statutory minimum requirements for energy efficiency and energy saving, the functions of complex-systems require reliable simulation, testing and checking right from the system development stage. Increasingly more parameters and tighter limits need to be considered. Requirements for measurement and testing are therefore also increasing considerably along with the need for higher performing measurement technology.



**You can find more solutions for industries:**  
[www.delphin.com](http://www.delphin.com)

## Application highlights

- Flexible and precise measurement technology that can be adapted by technicians to the relevant testing requirements
- Automated processing of stored test procedures, easy selection via "one-button solutions"
- Universal inputs for sensor technology, both open and proprietary interfaces as well as standardised protocols
- Easy integration of third-party measuring equipment such as scales or gas meters
- Fast data acquisition with up to 50,000 readings per second per channel
- High-performance internal computing and monitoring functions
- Alarms via switching output, text messaging, fax or email in the event of faults or limit value violations
- Online analyses during ongoing measurements, comparison of measurement results against databases and spreadsheets



# Application development

## Individual and efficient

Do you need a turnkey solution for your measurement or automation requirements? We at Delphin guarantee smooth project completion, from engineering and implementation through to user training. Using Delphin products, our engineering team efficiently and cost-effectively create individualised applications. This can include configuring measuring points, visualisation in ProfiSignal Basic, system automation and protocols in ProfiSignal Klicks or complete project planning and control cabinet construction by Delphin.

Application development is based on the ProfiSignal system. You can then subsequently maintain and develop the application we have created. Our engineers have been working for years with our products and are therefore able to deliver effective and practical solutions. Benefit from our many years of experience in delivering projects for specific customer needs and choose application development from Delphin.

 **You can find more application examples online:**  
[www.delphin.com](http://www.delphin.com)







## Application development services

- Specification of your application
- Development of a complete ProfiSignal application
- Design and implementation of visualisation diagrams for operating and observing
- Creation of input masks
- Development and testing of Klicks programming
- Report layout and linking as well as reports with measurement results
- Inclusion of corporate design requirements
- Data logger configuration
- Driver development
- Integration of additional equipment such as power meters, thermostats, controllers, scales, pumps etc. via RS232, 422, 485, Ethernet, OPC
- Connection to existing database systems for accessing and storing data
- Development of special software modules
- Planning and construction of control cabinets
- Preparation of full documentation
- Software installation and configuration
- Factory acceptance tests
- Application implementation
- Support in the preparation of validation documents (DQ, IQ, OQ) and system qualification
- User training
- Servicing and maintenance

# Application development

## Completed projects

### Test stand automation – Compressor test stand

A pump manufacturer is performing automated production tests simultaneously on seven test stands. Each test stand can be started and stopped individually from a PC. The test data is exchanged with a production database via ODBC. Tests begin with parameter input. From a dropdown list, users select one of the predefined test items to determine the test sample type. Recording and storing of measurement data begins at the click of a button. A colour change in a digital display indicates which value is below and which is above the permitted range.



## Completed projects

### Environmental simulation and service life testing – Climatic chambers

Eight refrigerators and four climatic chambers are being operated in a chemical research department. These chambers are used to store samples for simulating environmental degradation. Temperatures recorded by RTD are stored by a ProfiMessage device, with limit value parametrisation taking place on a PC. User management has been configured in ProfiSignal Klicks. Depending on rights, users can view current temperatures and trend graphs and configure limits. A written protocol is generated automatically.







### Other application examples

- Complete development test stands with the input of header data and product data, test procedure programming, standards-compliant protocols and calculations, e.g. for:
  - Luminaires
  - Tools
  - Motors
  - Vehicle components
  - Boilers and heating systems
- Process visualisation with data archiving and analysis functions, e.g. for:
  - Laboratories
  - R & D applications
  - Processing plants
- Final test systems with traceable, server-based data archiving and automatic printout of protocols for specific products
- Room monitoring and alarms via email, text messaging and fax, controlled by a powerful system of user management
- Vibration monitoring of engines, generators and turbines with worldwide accessibility to measurement data



**You can find more application examples online:**  
[www.delphin.com](http://www.delphin.com)

# Calibration

## Precision and security

Wherever measuring devices are being used for quality-based tasks, the devices require calibration. Even the smallest measurement errors can have drastic effects on the safety of production processes and on the quality of products. During calibration, measurements are carried out on the instrument to be tested and compared with reference values. This reassures users that measurements post calibration have a specific degree of accuracy. Every measuring system produced by Delphin leaves our factory calibrated and compliant to national standards according to ISO 9001.

We provide device and system recalibration at any time post purchase. As a manufacturer, we can re-adjust for deviations (if necessary) as part of a calibration, and carry out full functional testing. This guarantees reliability and accuracy over the entire period of use. We offer calibration at Delphin's premises or directly at the place of use.

For both on-site and in-house calibration at Delphin, you receive a calibration certificate for the device that complies to national standards. You have the option of DAkkS or factory calibration.



Mobile calibration system







## Calibration at Delphin

Calibration at Delphin makes sense when you have periods when you are not using the equipment. Arrange an appointment with our calibration department and send in the devices.

## On-site calibration

Larger machines and systems cannot be easily dismantled for calibration. For more complex systems, there is also risks involved in transportation. We then recommend that you have your equipment calibrated on site. For this purpose, we have modern and mobile calibration equipment which allows us to calibrate directly on your system and, if necessary, also to readjust it.

## Advantages of on-site calibration

- Minimal downtimes because the devices and systems remain in-house
- Measuring operations can continue because devices are calibrated one after the other
- The devices and systems are calibrated under actual ambient conditions
- Calibration takes place on an agreed date
- No effort or costs concerning dismantling, shipping and reassembly
- No transportation risks for the devices

# Services

## Training

Do you want to quickly and simply find out about the range of application options for Delphin measuring and testing devices and software? Or do you need support with implementing a specific application?

Then choose one of our regular basic or advanced training courses, or arrange an individual training course in which your specific questions will be dealt with according to your needs. Training can take place in the modern conference rooms at Delphin as well as at your premises.

Contact us and we will be happy to help you.

## Installation

To enable you to use your Delphin system as quickly as possible, we offer system installation at your premises by our qualified service engineers. We will make an appointment with you for this purpose. Installation includes the following:

- Setting up the Delphin measuring hardware
- Setting up the ProfiSignal software
- Miscellaneous e.g. cabling work
- Operating instructions

Installation therefore includes optimal configuration of your systems and training of your personnel. This makes using our products as easy as possible.

Give us a call and we will be happy to advise you.







### Rental contracts including software maintenance

Do you find that regularly checking whether your measurement technology software is up-to-date requires too much effort? Then opt for the rental variant of ProfiSignal. You can then stay up-to-date with the latest software version while also enjoying premium customer support for any queries you have.

All ProfiSignal rental licenses include the following services:

- Premium support by telephone and remote maintenance via internet with prescribed response times
- Free software updates for your ProfiSignal installation

[Contact us if you require more information.](#)

### Service agreements

Does the availability of your systems have top priority for you, no matter whether you operate a production plant, supervise a research and development facility or are a service provider? Do you use, or plan to use, Delphin products for data acquisition, monitoring and control tasks?

Then invest too in a service agreement for the measuring equipment supplied by Delphin to ensure continuous functioning of your system.

Delphin service agreements include the following options:

- Premium support by telephone and remote maintenance via internet with prescribed response times
- Short, contractually agreed lead times for service calls, maintenance work and repairs
- Free software updates for your ProfiSignal installation

[Request an offer tailored to the needs of your systems and facilities.](#)

# Notes

---





Delphin Technology AG  
Lustheide 81  
51427 Bergisch Gladbach · Germany

Phone +49 (0) 2204 97685-0  
Fax +49 (0) 2204 97685-85  
info@delphin.de · www.delphin.com

